

Article number: 20958442

Description: E+G Levelling foot
GN 343.3-32-M8-G

Measures

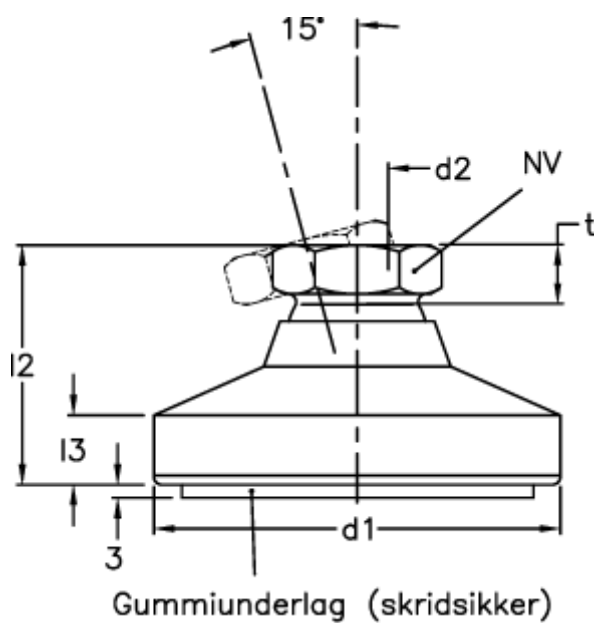

$d1$	= 32
$d2$	= M 8
$l2$	= 22.5
$l3$	= 5.0
NV	= 12.0
Static load (N)	= 7000
t min	= 9.0